

CHAPTER 1 SOLUTIONS

(1-1)

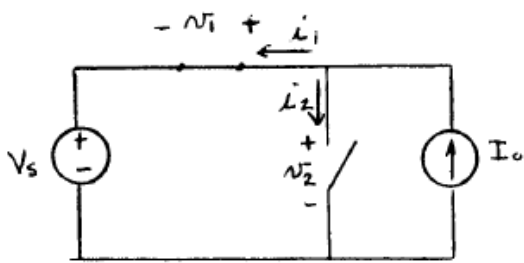

$$S_1: i_1 = I_o > 0, v_1 = 0$$

$$S_2: i_2 = 0, v_2 = V_s > 0$$

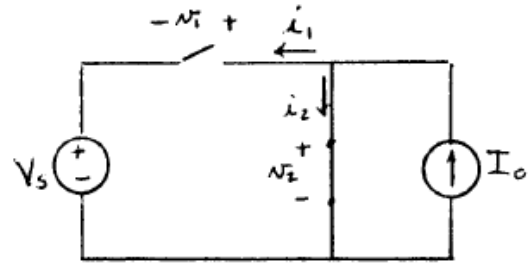

$$S_1: i_1 = 0, v_1 = -V_s < 0$$

$$S_2: i_2 = I_o > 0, v_2 = 0$$

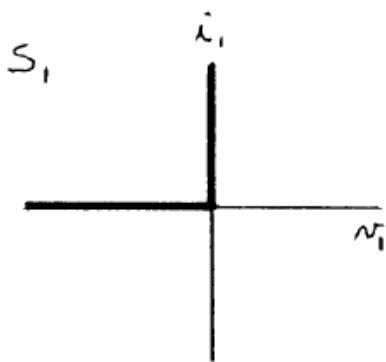

S1: Diode is sufficient

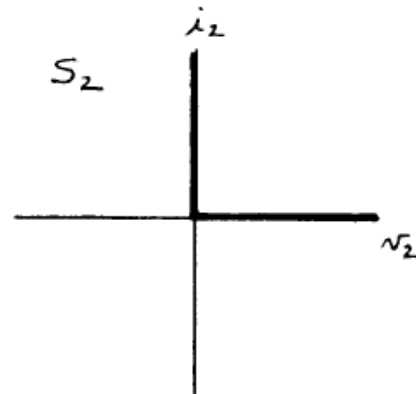

S2: Controlled device,
e.g., MOSFET

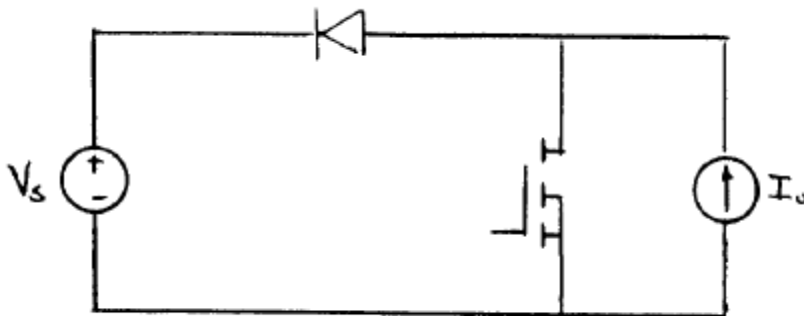

(1-2)

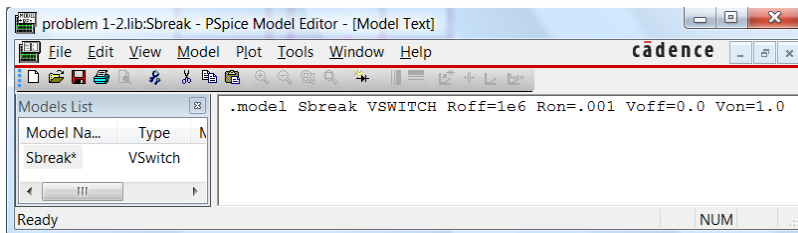
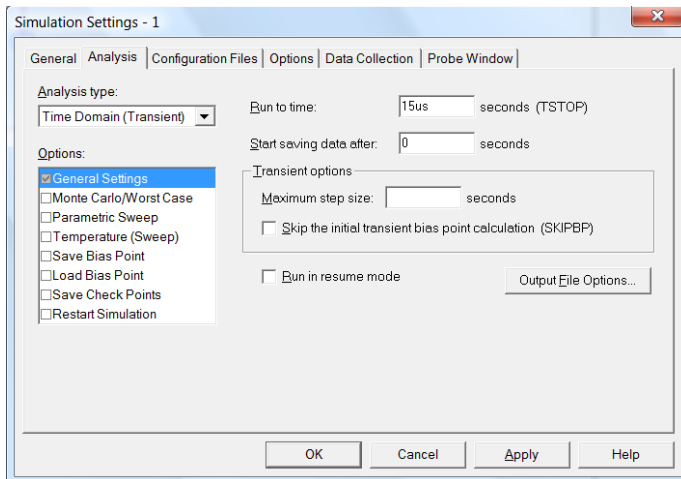
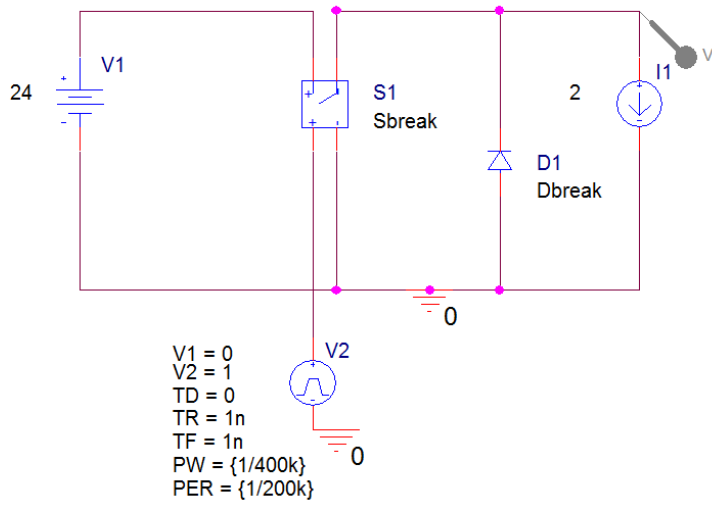

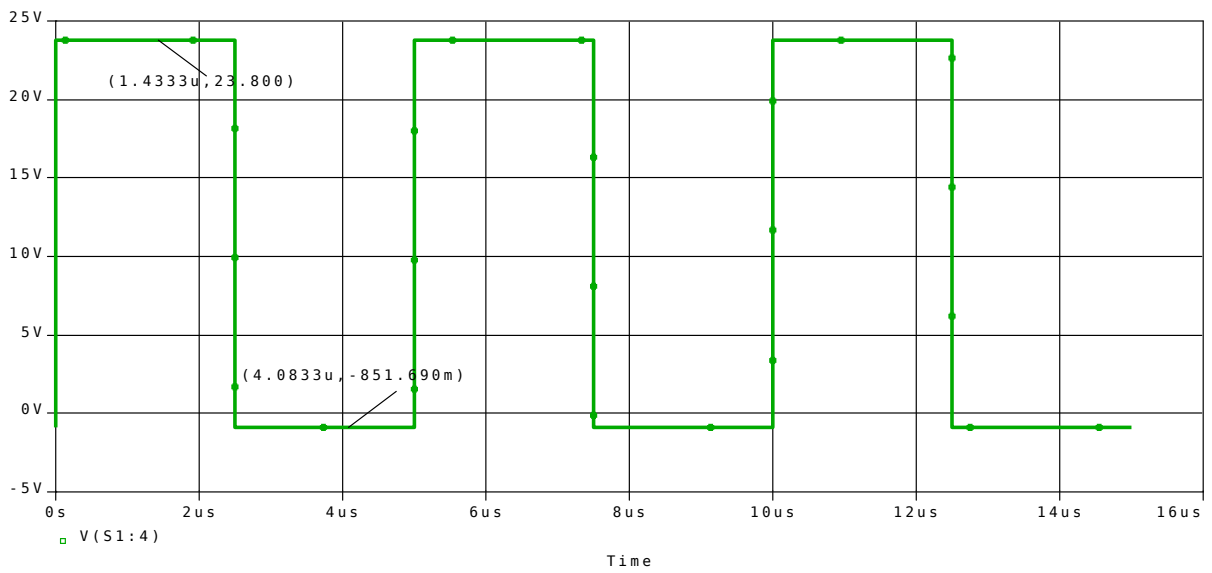
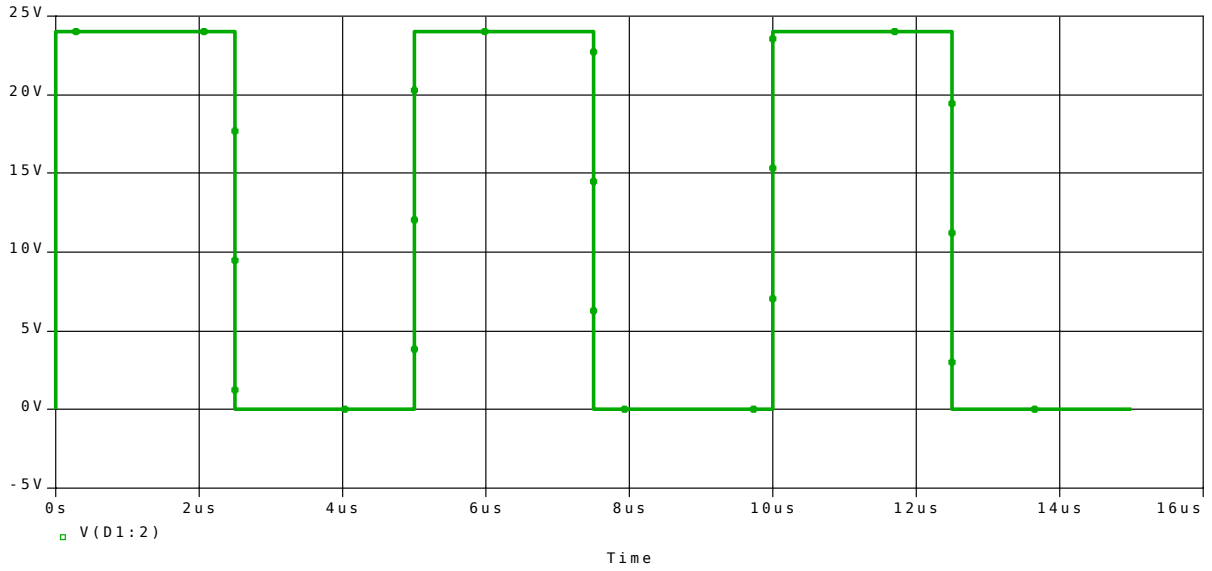

In part (b), the voltage across the current source is reduced from 24 V by the switch resistance and diode voltage drop.

(1-3)

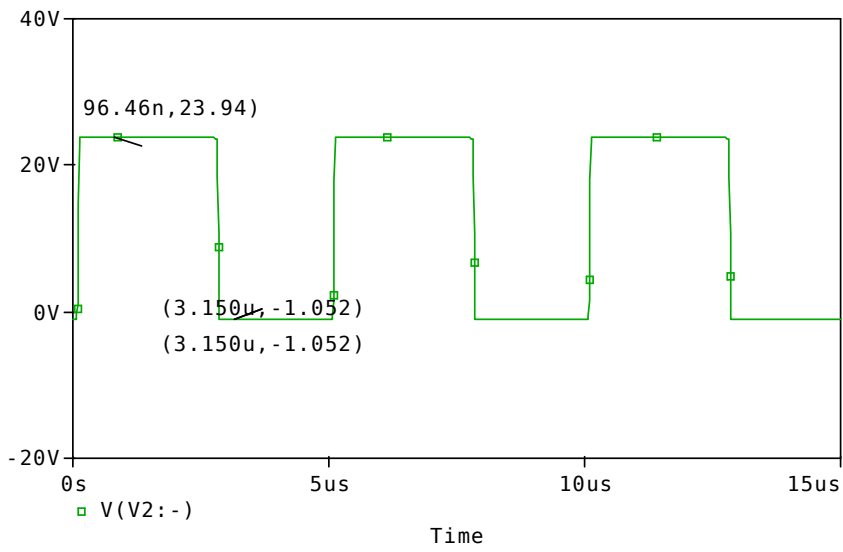
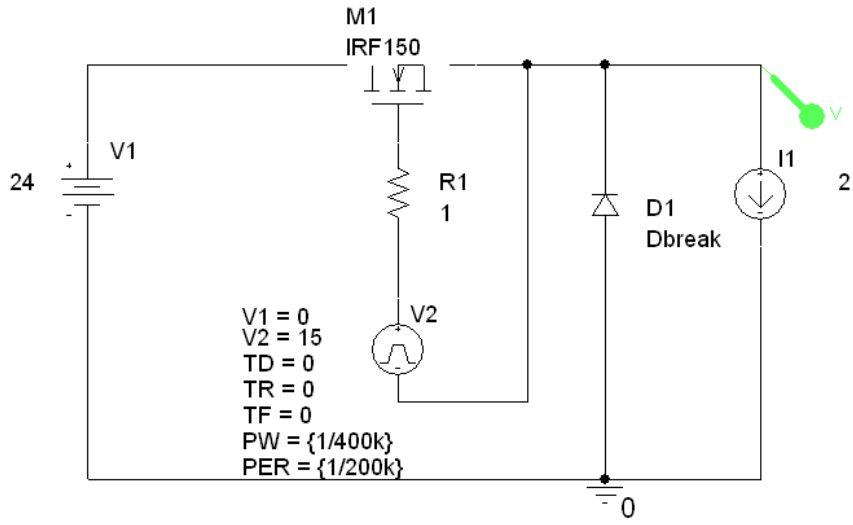

(1-4)

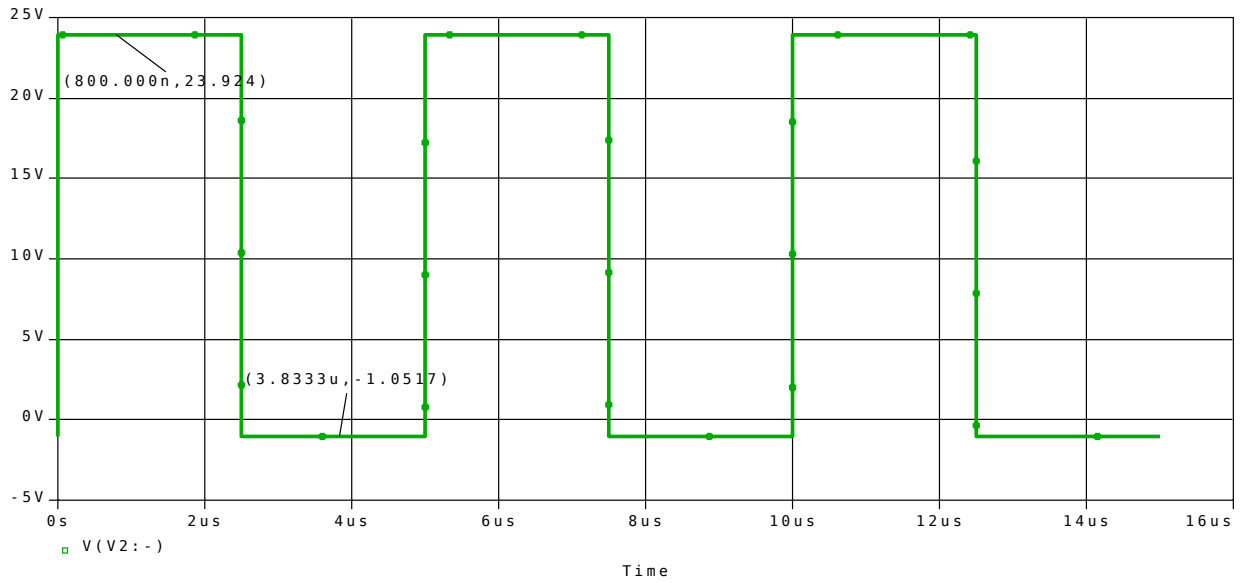
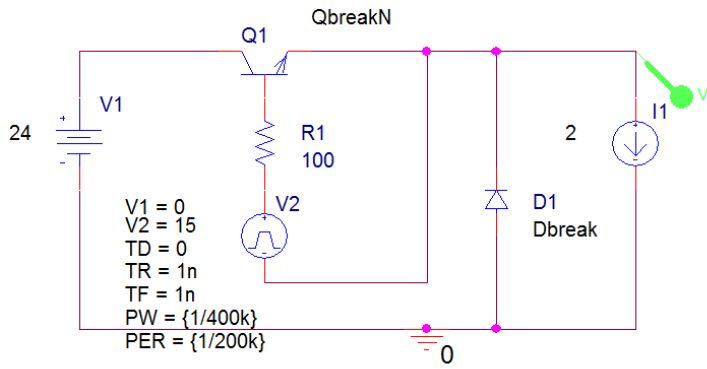

CHAPTER 2 SOLUTIONS

2/21/10

2-1) Square waves and triangular waves for voltage and current are two examples.

2-2) a) $p(t) = v(t)i(t) = \frac{v^2(t)}{R} = \frac{[170\sin(377t)]^2}{10} = 2890\sin^2 377t \text{ W.}$

b) peak power = 2890 W.

c) $P = 2890/2 = 1445 \text{ W.}$

2-3)

$v(t) = 5\sin 2\pi t \text{ V.}$

a) $4\sin 2\pi t \text{ A.}; p(t) = v(t)i(t) = 20 \sin^2 2\pi t \text{ W.}; P = 10 \text{ W.}$

b) $3\sin 4\pi t \text{ A.}; p(t) = 15\sin(2\pi t)\sin(4\pi t) \text{ W.}; P = 0$

2-4) a)

$$p(t) = v(t)i(t) = \begin{cases} 0 & 0 < t < 50 \text{ ms} \\ 40 & 50 \text{ ms} < t < 70 \text{ ms} \\ 0 & 70 \text{ ms} < t < 100 \text{ ms} \end{cases}$$

b)

$$P = \frac{1}{T} \int_0^T v(t)i(t) dt = \frac{1}{100 \text{ ms}} \int_{50 \text{ ms}}^{70 \text{ ms}} 40 dt = 8.0 \text{ W.}$$

c)

$$W = \int_0^T p(t) dt = \int_{50 \text{ ms}}^{70 \text{ ms}} 40 dt = 800 \text{ mJ.}; \text{ or } W = PT = (8 \text{ W})(100 \text{ ms}) = 800 \text{ mJ.}$$

2-5) a)

$$p(t) = v(t)i(t) = \begin{cases} 70 \text{ W.} & 0 < t < 6 \text{ ms} \\ -50 \text{ W.} & 6 \text{ ms} < t < 10 \text{ ms} \\ 40 \text{ W.} & 10 \text{ ms} < t < 14 \text{ ms} \\ 0 & 14 \text{ ms} < t < 20 \text{ ms} \end{cases}$$

b)

$$P = \frac{1}{T} \int_0^T p(t) dt = \frac{1}{20 \text{ ms}} \left[\int_0^{6 \text{ ms}} 70 dt + \int_{6 \text{ ms}}^{10 \text{ ms}} (-50) dt + \int_{10 \text{ ms}}^{14 \text{ ms}} 40 dt \right] = 19 \text{ W.}$$

c)

$$W = \int_0^T p(t) dt = \left[\int_0^{6ms} 70 dt + \int_{6ms}^{10ms} (-50) dt + \int_{10ms}^{14ms} 40 dt \right] = 0.38 J.;$$

$$\text{or } W = PT = (19)(20ms) = 380 mJ.$$

2-6)

$$P = V_{dc} I_{avg}$$

$$a) I_{avg} = 2 A., P = (12)(2) = 24 W.$$

$$b) I_{avg} = 3.1 A., P = (12)(3.1) = 37.2 W.$$

2-7)

a)

$$v_R(t) = i(t)R = 25 \sin 377t V.$$

$$p(t) = v(t)i(t) = (25 \sin 377t)(1.0 \sin 377t) = 25 \sin^2 377t = 12.5(1 - \cos 754t) W.$$

$$P_R = \frac{1}{T} \int_0^T p(t) dt = 12.5 W.$$

b)

$$v_L(t) = L \frac{di(t)}{dt} = 10(10)^{-3} (377)(1.0) \cos 377t = 3.77 \cos 377t V.$$

$$p_L(t) = v(t)i(t) = (3.77 \cos 377t)(1.0 \sin 377t) = \frac{(3.77)(1.0)}{2} \sin 754t = 1.89 \sin 754t W.$$

$$P_L = \frac{1}{T} \int_0^T p(t) dt = 0$$

c)

$$p(t) = v(t)i(t) = (12)(1.0 \sin 377t) = 12 \sin 377t W.$$

$$P_{dc} = \frac{1}{T} \int_0^T p(t) dt = 0$$

2-8) Resistor:

$$v(t) = i(t)R = 8 + 24 \sin 2\pi 60t \text{ V.}$$

$$p(t) = v(t)i(t) = (8 + 24 \sin 2\pi 60t)(2 + 6 \sin 2\pi 60t)$$

$$= 16 + 96 \sin 2\pi 60t + 144 \sin^2 2\pi 60t \text{ W.}$$

$$P = \frac{1}{T} \int_0^T p(t) dt = \frac{1}{1/60} \left[\int_0^{1/60} 16 dt + \int_0^{1/60} 96 \sin 2\pi 60t dt + \int_0^{1/60} 144 \sin^2 2\pi 60t dt \right]$$
$$= 16 + 72 = 88 \text{ W.}$$

Inductor: $P_L = 0$.

dc source: $P_{dc} = I_{avg} V_{dc} = (2)(6) = 12 \text{ W}$.

2-9) a) With the heater on,

$$P = \frac{V_m I_m}{2} = 1500 \text{ W.} \rightarrow I_m = \frac{(1500)(2)}{120\sqrt{2}} = 12.5\sqrt{2}$$

$$p(t) = V_m I_m \sin^2 \omega t = (120\sqrt{2})(12.5\sqrt{2}) \sin^2 \omega t = 3000 \sin^2 \omega t$$

$$\max(p(t)) = 3000 \text{ W.}$$

b) $P = 1500(5/12) = 625 \text{ W}$.

c) $W = PT = (625 \text{ W})(12 \text{ s}) = 7500 \text{ J}$. (or $1500(5) = 7500 \text{ W}$.)

2-10)

$$i_L(t) = \frac{1}{L} \int v_L(t) dt = \frac{1}{0.1} \int_0^t 90 d\lambda = 900t \quad 0 < t < 4 \text{ ms.}$$

$$i_L(4 \text{ ms}) = (900)(4)(10)^{-3} = 3.6 \text{ A.}$$

a)

$$W = \frac{1}{2} Li^2 = \frac{1}{2} (0.1)(3.6)^2 = 0.648 \text{ J.}$$

b) All stored energy is absorbed by R: $W_R = 0.648 \text{ J}$.

c)

$$P_R = \frac{W_R}{T} = \frac{0.648}{40 \text{ ms}} = 16.2 \text{ W.}$$

$$P_S = P_R = 16.2 \text{ W.}$$

d) No change in power supplied by the source: 16.2 W .
